

**NOT RECOMMENDED FOR NEW DESIGNS  
POSSIBLE SUBSTITUTE PRODUCT  
(ISL55001)**

**Low Power/Low Voltage 120MHz Unity-Gain Stable Operational Amplifier**



The EL2044 is a high speed, low power, low cost monolithic operational amplifier built on Elantec's proprietary

complementary bipolar process. The EL2044 is unity-gain stable and features a 325V/μs slew rate and 120MHz gain-bandwidth product while requiring only 5.2mA of supply current.

The power supply operating range of the EL2044 is from ±18V down to as little as ±2V. For single-supply operation, the EL2044 operates from 36V down to as little as 2.5V. The excellent power supply operating range of the EL2044 makes it an obvious choice for applications on a single +5V supply.

The EL2044 also features an extremely wide output voltage swing of ±13.6V with  $V_S = \pm 15V$  and  $R_L = 1k\Omega$ . At ±5V, output voltage swing is a wide ±3.8V with  $R_L = 500\Omega$  and ±3.2V with  $R_L = 150\Omega$ . Furthermore, for single-supply operation at +5V, output voltage swing is an excellent 0.3V to 3.8V with  $R_L = 500\Omega$ .

At a gain of +1, the EL2044 has a -3dB bandwidth of 120MHz with a phase margin of 50°. Because of its conventional voltage-feedback topology, the EL2044 allows the use of reactive or non-linear elements in its feedback network. This versatility combined with low cost and 75mA of output-current drive makes the EL2044 an ideal choice for price-sensitive applications requiring low power and high speed.

The EL2044 is available in the 8-pin SO and 8-pin PDIP packages and operates over the full -40°C to +85°C temperature range.

**Ordering Information**

PART NUMBER	PACKAGE	TAPE & REEL	PKG. DWG. #
EL2044CS	8-Pin SO	-	MDP0027
EL2044CSZ (See Note)	8-Pin SO (Pb-free)	-	MDP0027
EL2044CS-T7	8-Pin SO	7"	MDP0027
EL2044CSZ-T7 (See Note)	8-Pin SO (Pb-free)	7"	MDP0027
EL2044CS-T13	8-Pin SO	13"	MDP0027
EL2044CSZ-T13 (See Note)	8-Pin SO (Pb-free)	13"	MDP0027
EL2044CN	8-Pin PDIP	-	MDP0031

NOTE: Intersil Pb-free products employ special Pb-free material sets; molding compounds/die attach materials and 100% matte tin plate termination finish, which is compatible with both SnPb and Pb-free soldering operations. Intersil Pb-free products are MSL classified at Pb-free peak reflow temperatures that meet or exceed the Pb-free requirements of IPC/JEDEC J Std-020B.

**Features**

- Pb-free available
- 120MHz -3dB bandwidth
- Unity-gain stable
- Low supply current - 5.2mA @  $V_S = \pm 15V$
- Wide supply range - ±2V to ±18V dual-supply and 2.5V to 36V single-supply
- High slew rate = 325V/μs
- Fast settling - 80ns to 0.1% for a 10V step
- Low differential gain - 0.04% at  $A_V = +2$ ,  $R_L = 150\Omega$
- Low differential phase - 0.15° at  $A_V = +2$ ,  $R_L = 150\Omega$
- Wide output voltage swing - ±13.6V with  $V_S = \pm 15V$ ,  $R_L = 1k\Omega$  and 3.8V/0.3V with  $V_S = +5V$ ,  $R_L = 500\Omega$
- Low cost, enhanced replacement for the AD847 and LM6361

**Applications**

- Video amplifiers
- Single-supply amplifiers
- Active filters/integrators
- High speed sample-and-hold
- High speed signal processing
- ADC/DAC buffers
- Pulse/RF amplifiers
- Pin diode receivers
- Log amplifiers
- Photo multiplier amplifiers
- Difference amplifiers

**Pinout**

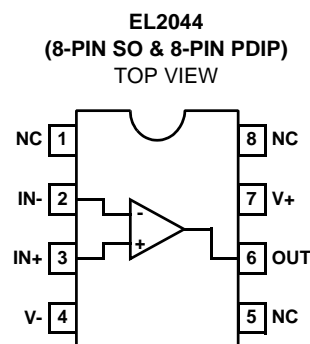

**Absolute Maximum Ratings** ( $T_A = 25^\circ\text{C}$ )

Supply Voltage ( $V_S$ ) .....  $\pm 18\text{V}$  or  $36\text{V}$   
 Input Voltage ( $V_{IN}$ ) .....  $\pm V_S$   
 Differential Input Voltage ( $dV_{IN}$ ) .....  $\pm 10\text{V}$   
 Continuous Output Current .....  $60\text{mA}$

Power Dissipation ( $P_D$ ) ..... See Curves  
 Operating Temperature Range ( $T_A$ ) .....  $-40^\circ\text{C}$  to  $+85^\circ\text{C}$   
 Operating Junction Temperature ( $T_J$ ) .....  $+150^\circ\text{C}$   
 Storage Temperature ( $T_{ST}$ ) .....  $-65^\circ\text{C}$  to  $+150^\circ\text{C}$

*CAUTION: Stresses above those listed in "Absolute Maximum Ratings" may cause permanent damage to the device. This is a stress only rating and operation of the device at these or any other conditions above those indicated in the operational sections of this specification is not implied.*

*IMPORTANT NOTE: All parameters having Min/Max specifications are guaranteed. Typical values are for information purposes only. Unless otherwise noted, all tests are at the specified temperature and are pulsed tests, therefore:  $T_J = T_C = T_A$*

**DC Electrical Specifications**  $V_S = \pm 15\text{V}$ ,  $R_L = 1\text{k}\Omega$ , unless otherwise specified.

PARAMETER	DESCRIPTION	CONDITION	TEMP	MIN	TYP	MAX	UNIT
$V_{OS}$	Input Offset Voltage	$V_S = \pm 15\text{V}$	$25^\circ\text{C}$		0.5	7.0	mV
			$T_{MIN}, T_{MAX}$			13.0	mV
$TCV_{OS}$	Average Offset Voltage Drift		All		10.0		$\mu\text{V}/^\circ\text{C}$
$I_B$	Input Bias Current	$V_S = \pm 15\text{V}$	$25^\circ\text{C}$		2.8	8.2	$\mu\text{A}$
			$T_{MIN}, T_{MAX}$			11.2	$\mu\text{A}$
		$V_S = \pm 5\text{V}$	$25^\circ\text{C}$		2.8		$\mu\text{A}$
$I_{OS}$	Input Offset Current	$V_S = \pm 15\text{V}$	$25^\circ\text{C}$		50	300	nA
			$T_{MIN}, T_{MAX}$			500	nA
		$V_S = \pm 5\text{V}$	$25^\circ\text{C}$		50		nA
$TCI_{OS}$	Average Offset Current Drift	(Note 1)	All		0.3		$\text{nA}/^\circ\text{C}$
$A_{VOL}$	Open-loop Gain	$V_S = \pm 15\text{V}, V_{OUT} = \pm 10\text{V}, R_L = 1\text{k}\Omega$	$25^\circ\text{C}$	800	1500		V/V
			$T_{MIN}, T_{MAX}$	600			V/V
		$V_S = \pm 5\text{V}, V_{OUT} = \pm 2.5\text{V}, R_L = 500\Omega$	$25^\circ\text{C}$		1200		V/V
		$V_S = \pm 5\text{V}, V_{OUT} = \pm 2.5\text{V}, R_L = 150\Omega$	$25^\circ\text{C}$		1000		V/V
PSRR	Power Supply Rejection Ratio	$V_S = \pm 5\text{V}$ to $\pm 15\text{V}$	$25^\circ\text{C}$	65	80		dB
			$T_{MIN}, T_{MAX}$	60			dB
CMRR	Common-mode Rejection Ratio	$V_{CM} = \pm 12\text{V}, V_{OUT} = 0\text{V}$	$25^\circ\text{C}$	70	90		dB
			$T_{MIN}, T_{MAX}$	70			dB
CMIR	Common-mode Input Range	$V_S = \pm 15\text{V}$	$25^\circ\text{C}$		$\pm 14.0$		V
		$V_S = \pm 5\text{V}$	$25^\circ\text{C}$		$\pm 4.2$		V
		$V_S = +5\text{V}$	$25^\circ\text{C}$		4.2/0.1		V
$V_{OUT}$	Output Voltage Swing	$V_S = \pm 15\text{V}, R_L = 1\text{k}\Omega$	$25^\circ\text{C}$	$\pm 13.4$	$\pm 13.6$		V
			$T_{MIN}, T_{MAX}$	$\pm 13.1$			V
		$V_S = \pm 15\text{V}, R_L = 500\Omega$	$25^\circ\text{C}$	$\pm 12.0$	$\pm 13.4$		V
		$V_S = \pm 5\text{V}, R_L = 500\Omega$	$25^\circ\text{C}$	$\pm 3.4$	$\pm 3.8$		V
		$V_S = \pm 5\text{V}, R_L = 150\Omega$	$25^\circ\text{C}$		$\pm 3.2$		V
		$V_S = +5\text{V}, R_L = 500\Omega$	$25^\circ\text{C}$	3.6/0.4	3.8/0.3		V
$I_{SC}$	Output Short Circuit Current		$25^\circ\text{C}$	40	75		mA
			$T_{MIN}, T_{MAX}$	35			mA

**DC Electrical Specifications**  $V_S = \pm 15V$ ,  $R_L = 1k\Omega$ , unless otherwise specified. (Continued)

PARAMETER	DESCRIPTION	CONDITION	TEMP	MIN	TYP	MAX	UNIT
I <sub>S</sub>	Supply Current	$V_S = \pm 15V$ , no load	25°C		5.2	7	mA
			T <sub>MIN</sub> , T <sub>MAX</sub>				7.6
		$V_S = \pm 5V$ , no load	25°C		5.0		
R <sub>IN</sub>	Input Resistance	Differential	25°C		150		k $\Omega$
		Common-mode	25°C		15		M $\Omega$
C <sub>IN</sub>	Input Capacitance	$A_V = +1$ @10MHz	25°C		1.0		pF
R <sub>OUT</sub>	Output Resistance	$A_V = +1$	25°C		50		m $\Omega$
PSOR	Power-supply Operating Range	Dual-supply	25°C	$\pm 2.0$		$\pm 18.0$	V
		Single-supply	25°C	2.5		36.0	V

NOTE:

1. Measured from T<sub>MIN</sub> to T<sub>MAX</sub>.

**Closed-Loop AC Electrical Specifications**  $V_S = \pm 15V$ ,  $A_V = +1$ ,  $R_L = 1k\Omega$  unless otherwise specified.

PARAMETER	DESCRIPTION	CONDITION	TEMP	MIN	TYP	MAX	UNIT
BW	-3dB Bandwidth ( $V_{OUT} = 0.4V_{PP}$ )	$V_S = \pm 15V$ , $A_V = +1$	25°C		120		MHz
		$V_S = \pm 15V$ , $A_V = -1$	25°C		60		MHz
		$V_S = \pm 15V$ , $A_V = +2$	25°C		60		MHz
		$V_S = \pm 15V$ , $A_V = +5$	25°C		12		MHz
		$V_S = \pm 15V$ , $A_V = +10$	25°C		6		MHz
		$V_S = \pm 5V$ , $A_V = +1$	25°C		80		MHz
GBWP	Gain-bandwidth Product	$V_S = \pm 15V$	25°C		60		MHz
		$V_S = \pm 5V$	25°C		45		MHz
PM	Phase Margin	$R_L = 1k\Omega$ , $C_L = 10pF$	25°C		50		°
SR	Slew Rate (Note 1)	$V_S = \pm 15V$ , $R_L = 1k\Omega$	25°C	250	325		V/ $\mu s$
		$V_S = \pm 5V$ , $R_L = 500\Omega$	25°C		200		V/ $\mu s$
FPBW	Full-power Bandwidth (Note 2)	$V_S = \pm 15V$	25°C	4.0	5.2		MHz
		$V_S = \pm 5V$	25°C		12.7		MHz
t <sub>R</sub> , t <sub>F</sub>	Rise Time, Fall Time	0.1V Step	25°C		3.0		ns
OS	Overshoot	0.1V Step	25°C		20		%
t <sub>PD</sub>	Propagation Delay		25°C		2.5		ns
t <sub>S</sub>	Settling to +0.1% ( $A_V = +1$ )	$V_S = \pm 15V$ , 10V step	25°C		80		ns
		$V_S = \pm 5V$ , 5V step			60		ns
dG	Differential Gain (Note 3)	NTSC/PAL	25°C		0.04		%
dP	Differential Phase	NTSC/PAL	25°C		0.15		°
eN	Input Noise Voltage	10kHz	25°C		15.0		nV/ $\sqrt{Hz}$
iN	Input Noise Current	10kHz	25°C		1.50		pA/ $\sqrt{Hz}$

NOTES:

1. Slew rate is measured on rising edge.
2. For  $V_S = \pm 15V$ ,  $V_{OUT} = 20V_{PP}$ . For  $V_S = \pm 5V$ ,  $V_{OUT} = 5V_{PP}$ . Full-power bandwidth is based on slew rate measurement using:  $FPBW = SR / (2\pi * V_{peak})$ .
3. Video performance measured at  $V_S = \pm 15V$ ,  $A_V = +2$  with 2 times normal video level across  $R_L = 150\Omega$ . This corresponds to standard video levels across a back-terminated 75 $\Omega$  load. For other values of  $R_L$ , see curves.

Typical Performance Curves

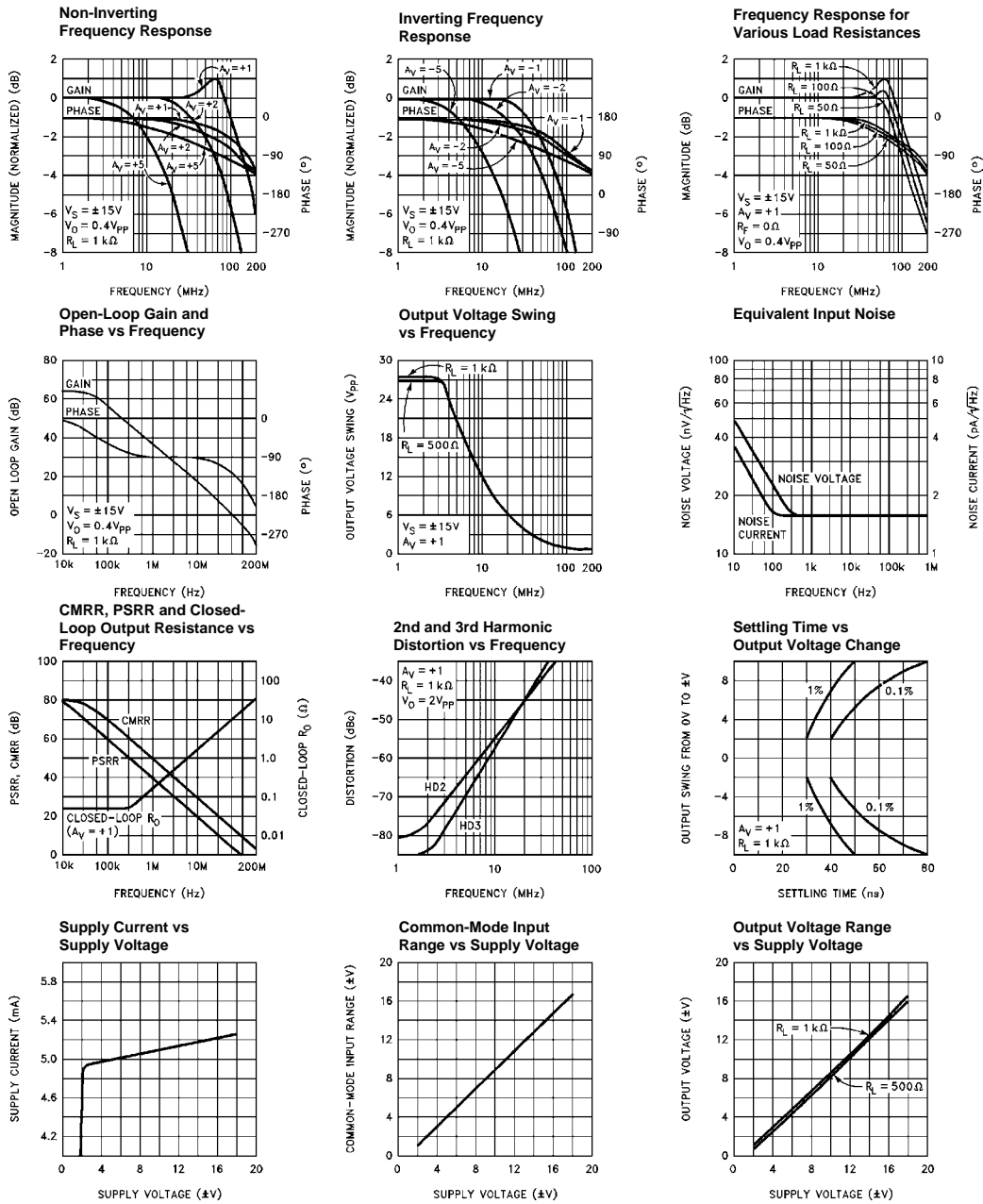

Typical Performance Curves (Continued)

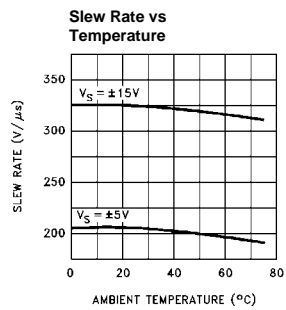
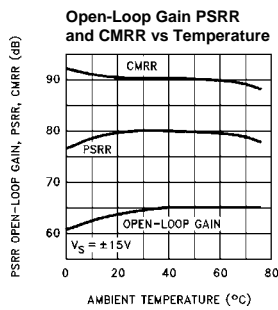
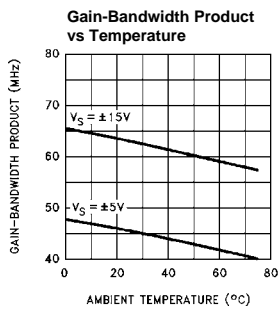
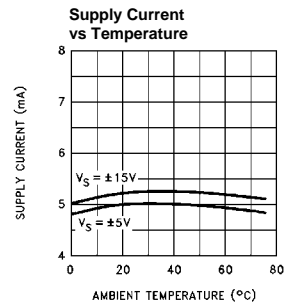
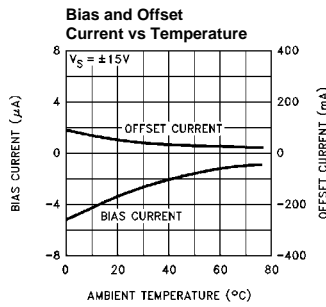
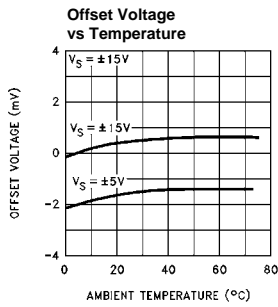
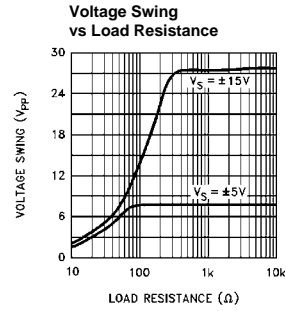
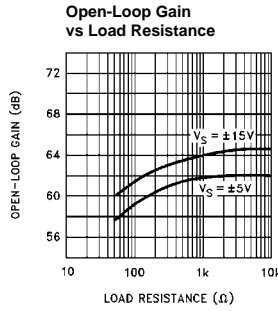
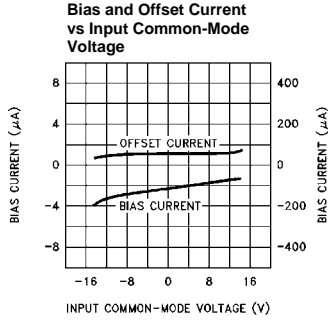
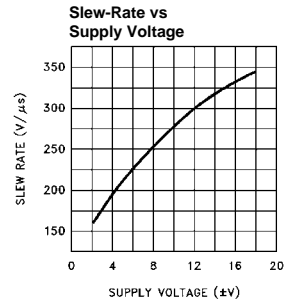
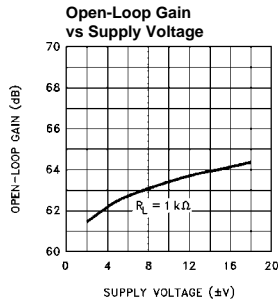
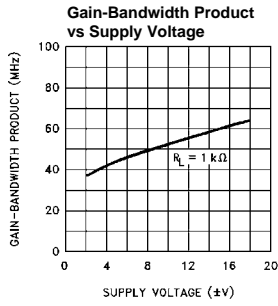

Typical Performance Curves (Continued)

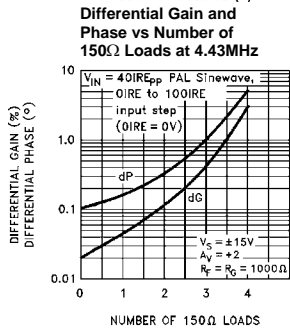
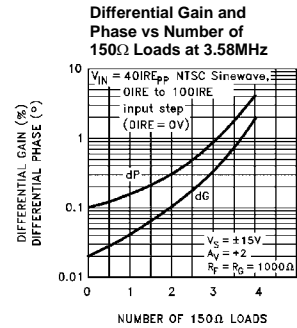
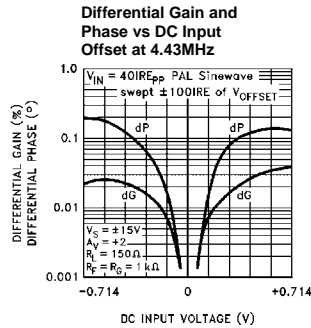
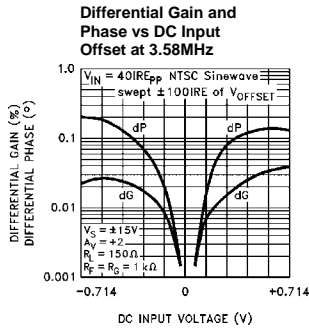
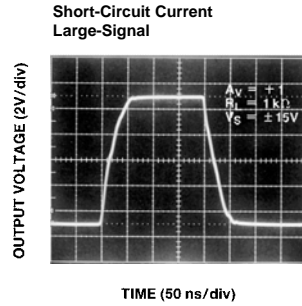
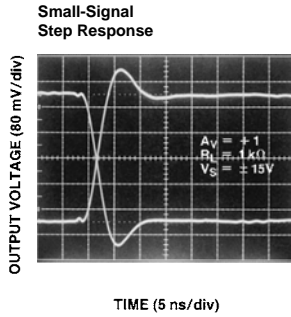
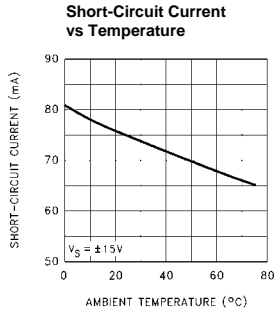

Gain-Bandwidth Product vs Load Capacitance

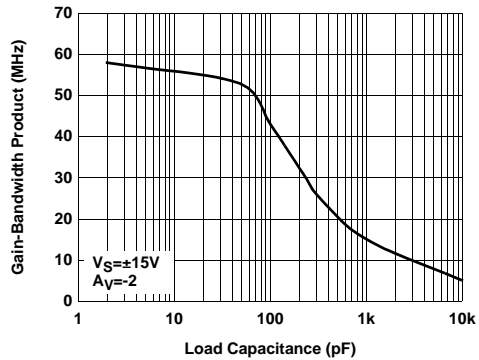

Overshoot vs Load Capacitance

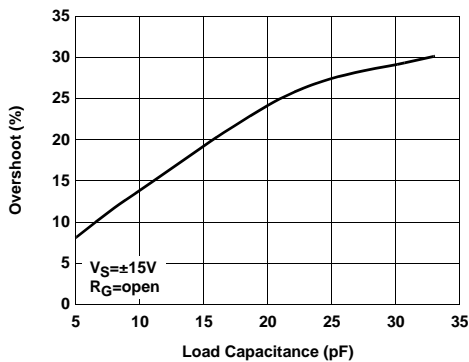

Package Power Dissipation vs Ambient Temperature  
JEDEC JESD51-3 Low Effective Thermal Conductivity Test Board

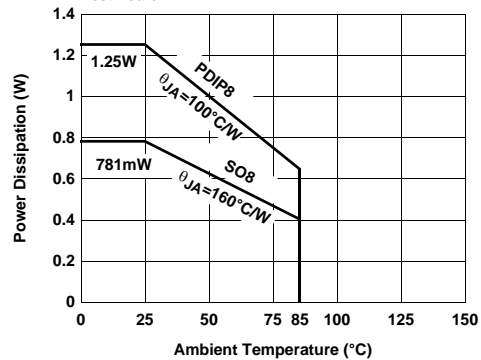

**Simplified Schematic**

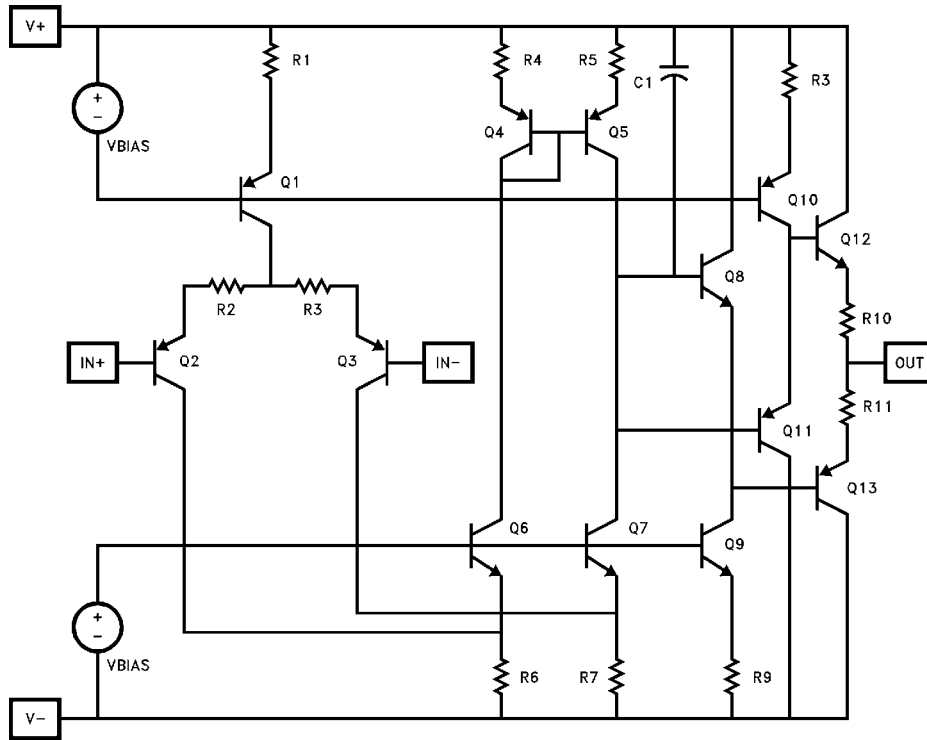

**Burn-In Circuit**

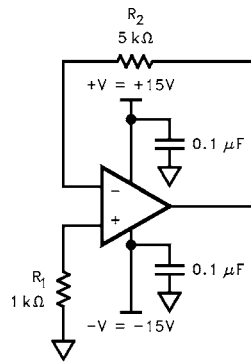

ALL PACKAGES USE THE SAME SCHEMATIC

**Applications Information**

**Product Description**

The EL2044 is a low-power wideband monolithic operational amplifier built on Elantec's proprietary high-speed complementary bipolar process. The EL2044 uses a classical voltage-feedback topology which allows it to be used in a variety of applications where current-feedback amplifiers are not appropriate because of restrictions placed upon the feedback element used with the amplifier. The conventional topology of the EL2044 allows, for example, a capacitor to be placed in the feedback path, making it an excellent choice for applications such as active filters,

sample-and-holds, or integrators. Similarly, because of the ability to use diodes in the feedback network, the EL2044 is an excellent choice for applications such as fast log amplifiers.

**Single-Supply Operation**

The EL2044 has been designed to have a wide input and output voltage range. This design also makes the EL2044 an excellent choice for single-supply operation. Using a single positive supply, the lower input voltage range is within 100mV of ground ( $R_L = 500\Omega$ ), and the lower output voltage range is within 300mV of ground. Upper input voltage range reaches 4.2V, and output voltage range reaches 3.8V with a

5V supply and  $R_L = 500\Omega$ . This results in a 3.5V output swing on a single 5V supply. This wide output voltage range also allows single-supply operation with a supply voltage as high as 36V or as low as 2.5V. On a single 2.5V supply, the EL2044 still has 1V of output swing.

### ***Gain-Bandwidth Product and the -3dB Bandwidth***

The EL2044 has a gain-bandwidth product of 60MHz while using only 5.2mA of supply current. For gains greater than 4, its closed-loop -3dB bandwidth is approximately equal to the gain-bandwidth product divided by the noise gain of the circuit. For gains less than 4, higher-order poles in the amplifier's transfer function contribute to even higher closed loop bandwidths. For example, the EL2044 has a -3dB bandwidth of 120MHz at a gain of +1, dropping to 60MHz at a gain of +2. It is important to note that the EL2044 has been designed so that this "extra" bandwidth in low-gain applications does not come at the expense of stability. As seen in the typical performance curves, the EL2044 in a gain of +1 only exhibits 1.0dB of peaking with a 1k $\Omega$  load.

### ***Video Performance***

An industry-standard method of measuring the video distortion of a component such as the EL2044 is to measure the amount of differential gain (dG) and differential phase (dP) that it introduces. To make these measurements, a 0.286V<sub>PP</sub> (40 IRE) signal is applied to the device with 0V DC offset (0 IRE) at either 3.58MHz for NTSC or 4.43MHz for PAL. A second measurement is then made at 0.714V DC offset (100 IRE). Differential gain is a measure of the change in amplitude of the sine wave, and is measured in percent. Differential phase is a measure of the change in phase, and is measured in degrees.

For signal transmission and distribution, a back-terminated cable (75 $\Omega$  in series at the drive end, and 75 $\Omega$  to ground at the receiving end) is preferred since the impedance match at both ends will absorb any reflections. However, when double termination is used, the received signal is halved; therefore a gain of 2 configuration is typically used to compensate for the attenuation.

The EL2044 has been designed as an economical solution for applications requiring low video distortion. It has been thoroughly characterized for video performance in the topology described above, and the results have been included as typical dG and dP specifications and as typical performance curves. In a gain of +2, driving 150 $\Omega$ , with standard video test levels at the input, the EL2044 exhibits dG and dP of only 0.04% and 0.15° at NTSC and PAL. Because dG and dP can vary with different DC offsets, the video performance of the EL2044 has been characterized over the entire DC offset range from -0.714V to +0.714V. For more information, refer to the curves of dG and dP vs DC Input Offset.

The output drive capability of the EL2044 allows it to drive up to 2 back-terminated loads with good video performance.

For more demanding applications such as greater output drive or better video distortion, a number of alternatives such as the EL2120, EL400, or EL2073 should be considered.

### ***Output Drive Capability***

The EL2044 has been designed to drive low impedance loads. It can easily drive 6V<sub>PP</sub> into a 150 $\Omega$  load. This high output drive capability makes the EL2044 an ideal choice for RF, IF and video applications. Furthermore, the current drive of the EL2044 remains a minimum of 35mA at low temperatures.

### ***Printed-Circuit Layout***

The EL2044 is well behaved, and easy to apply in most applications. However, a few simple techniques will help assure rapid, high quality results. As with any high-frequency device, good PCB layout is necessary for optimum performance. Ground-plane construction is highly recommended, as is good power supply bypassing. A 0.1 $\mu$ F ceramic capacitor is recommended for bypassing both supplies. Lead lengths should be as short as possible, and bypass capacitors should be as close to the device pins as possible. For good AC performance, parasitic capacitances should be kept to a minimum at both inputs and at the output. Resistor values should be kept under 5k $\Omega$  because of the RC time constants associated with the parasitic capacitance. Metal-film and carbon resistors are both acceptable, use of wire-wound resistors is not recommended because of their parasitic inductance. Similarly, capacitors should be low-inductance for best performance.

### ***The EL2044 Macromodel***

This macromodel has been developed to assist the user in simulating the EL2044 with surrounding circuitry. It has been developed for the PSPICE simulator (copywritten by the Microsim Corporation), and may need to be rearranged for other simulators. It approximates DC, AC, and transient response for resistive loads, but does not accurately model capacitive loading. This model is slightly more complicated than the models used for low-frequency op-amps, but it is much more accurate for AC analysis.

The model does not simulate these characteristics accurately:

- Noise
- Settling time
- Non-linearities
- Temperature effects
- Manufacturing variations
- CMRR
- PSRR



**EL2044 Macromodel**

IN+IN+IN+IN+IN+IN+NININININ

\* Connections: +input

```

*           |      -input
*           |      |      +Vsupply
*           |      |      |      -Vsupply
*           |      |      |      |      output
*           |      |      |      |      |
.subckt M2044 3 2 7 4 6

```

\* Input stage

```

*
ie 7 37 1mA
r6 36 37 800
r7 38 37 800
rc1 4 30 850
rc2 4 39 850
q1 30 3 36 qp
q2 39 2 38 qpa
ediff 33 0 39 30 1.0
rdiff 33 0 1Meg

```

\* Compensation Section

```

*
ga 0 34 33 0 1m
rh 34 0 2Meg
ch 34 0 1.3pF
rc 34 40 1K
cc 40 0 1pF

```

\* Poles

```

*
ep 41 0 40 0 1
rpa 41 42 200
cpa 42 0 1pF
rpb 42 43 200
cpb 43 0 1pF

```

\* Output Stage

```

*
ios1 7 50 1.0mA
ios2 51 4 1.0mA
q3 4 43 50 qp
q4 7 43 51 qn
q5 7 50 52 qn
q6 4 51 53 qp
ros1 52 6 25
ros2 6 53 25

```

\* Power Supply Current

```

*
ips 7 4 2.7mA

```

IN+IN+IN+IN+IN+IN+NININININ

\* Models

```

*
.model qn npn(is=800E-18 bf=200 tf=0.2nS)
.model qpa pnp(is=864E-18 bf=100 tf=0.2nS)
.model qp pnp(is=800E-18 bf=125 tf=0.2nS)
.ends

```

EL2044 Macromodel (Continued)

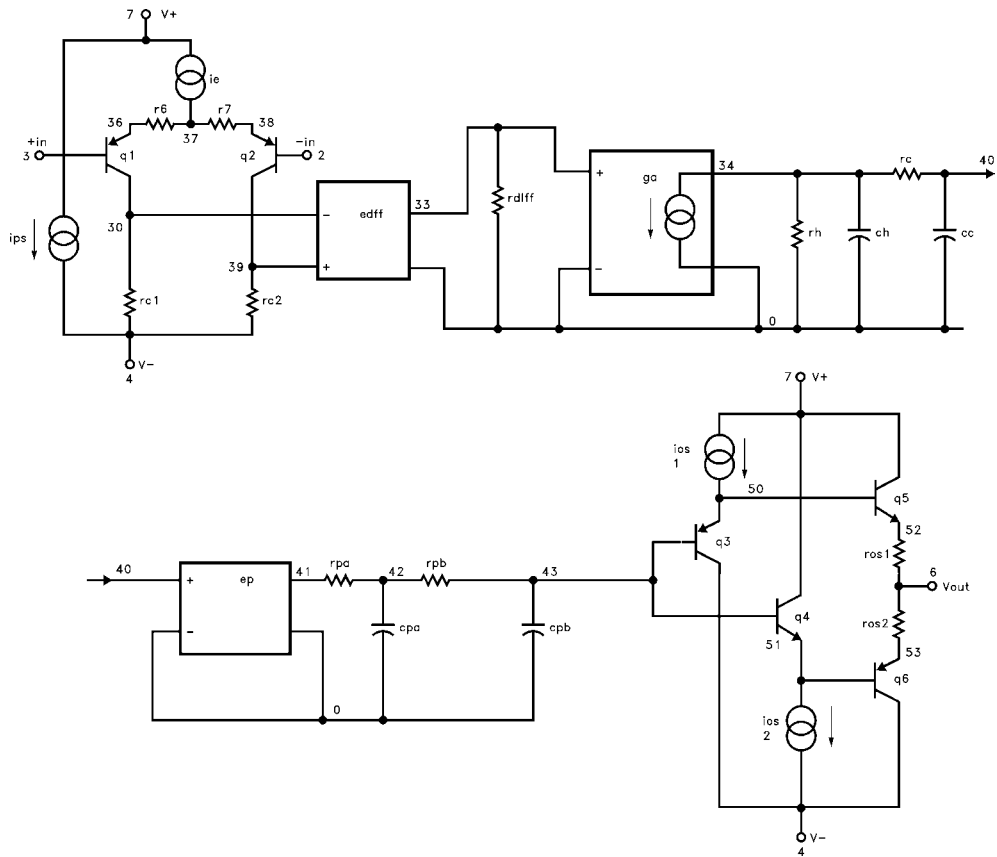

All Intersil U.S. products are manufactured, assembled and tested utilizing ISO9000 quality systems.  
Intersil Corporation's quality certifications can be viewed at [www.intersil.com/design/quality](http://www.intersil.com/design/quality)

*Intersil products are sold by description only. Intersil Corporation reserves the right to make changes in circuit design, software and/or specifications at any time without notice. Accordingly, the reader is cautioned to verify that data sheets are current before placing orders. Information furnished by Intersil is believed to be accurate and reliable. However, no responsibility is assumed by Intersil or its subsidiaries for its use; nor for any infringements of patents or other rights of third parties which may result from its use. No license is granted by implication or otherwise under any patent or patent rights of Intersil or its subsidiaries.*

For information regarding Intersil Corporation and its products, see [www.intersil.com](http://www.intersil.com)